

N

Monteringsanvisning

EN

Assembly Instructions

S

Monteringsanvisning

Produkt nr. / Product no. / Produkt nr.

60-164-940**Gul**

Ord. nr. _____

Dato. _____

Sign. _____

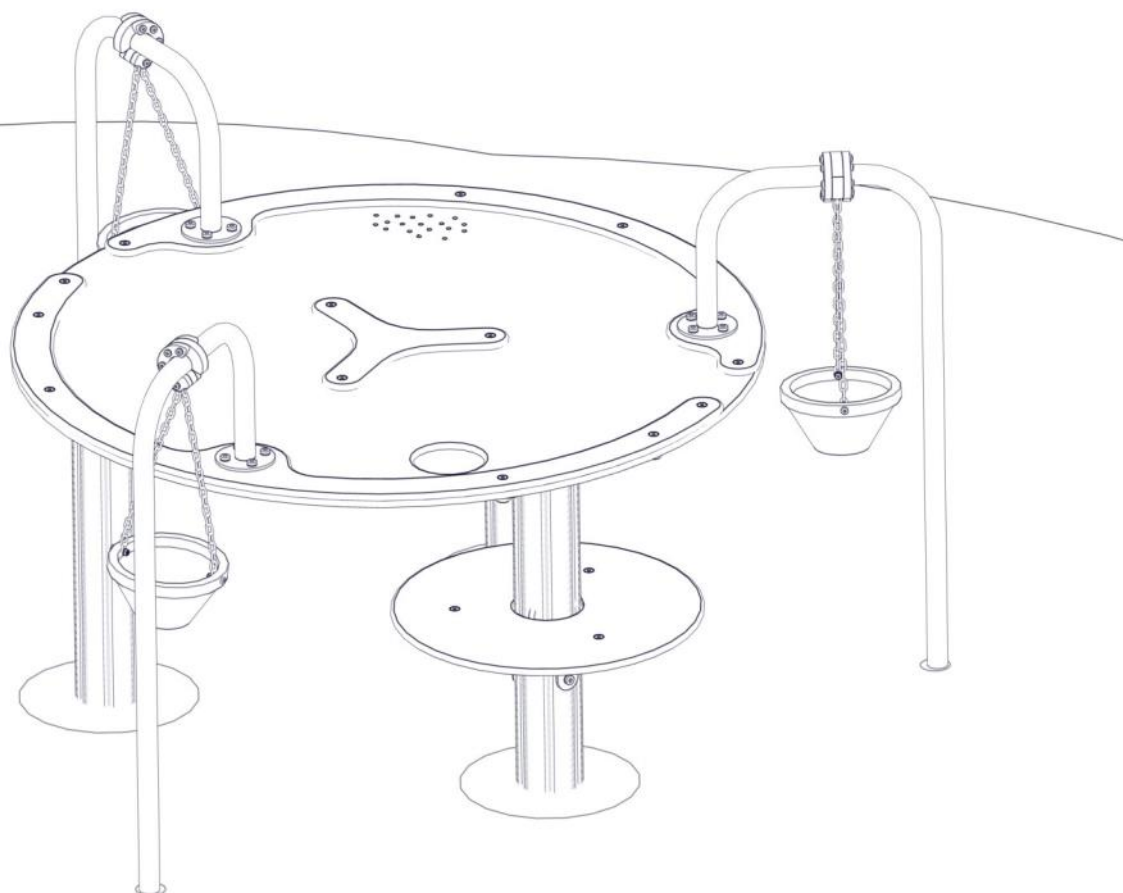
**søve**

Søve AS
 Grønnvoldveien 290
 3830 Ulefoss - Norway
 Tlf: +47 35 94 65 65
www.sove.no

**søve**

Søve AB
 EA Rosengrensgatan 32
 421 31 Västra Frölunda
 Phone: +46 (0)31 773 97 00
www.sove.se

Monteringstips / Assembly Advice / Monteringsstips**N**

- Les monteringsanvisningen nøye før montering.
- Monter elementene i rekkefølgen som vist.
- Boltene bør ikke skrues for hardt til før alt er montert, vatret og loddet. Skru så boltene til.
- NB! Ved bruk av drill, kan boltene ryke.
- På grunn av at solen kan gjøre rutsjeflaten veldig varm, bør rutsjebanens utløp vende mot nord-øst eller nord-vest.
- Er lekeutstyret plassert i naturlige ferdselstraséer må området sikres mot gjennomgang.
- Innspringningshinder bør vurderes rundt lekeapparater hvor det er stor bevegelse, f.eks. ved huskestativ.
- Det bør være fritt innsyn til lekeutstyr som er beregnet for barn under 3 år.

NB! Under monteringsarbeidet må utstyr, som ikke er forankret forsvarlig i bakken, sikres slik at det ikke velte.

Området må avstenges under montering av apparatene med sperrebånd eller lignende.

EN

- Read the instruction carefully before assembling the play unit.
- Assemble the components in the sequence shown in these instructions. Fixings must not be fully tightened during assembly. Before casting the foundations, the structure must be level and plumb, at which point all fixings are tightened. PS! If use of drill, the bolts may be wrecked.
- Avoid positioning the slide facing due south because of overheating – ideal positions are facing north-east or north-west. Secure the construction-area to prevent people from walking through it.
- Consider installing barriers around play-equipment which gives rise to a lot of activity – i.e. swings.
- Ensure that clear vision is possible across the play area so that supervision is possible from any position, particularly where children under 3 years of age will be playing.

NB! During assembly of the equipment, ensure that all structures are securely propped, especially when left overnight. Also ensure that equipment is supported

Monteringstips / Assembly Advice / Monteringsstips**S**

- Läs monteringsanvisningen noga före montering.

- Montera delarna i den ordningen som anvisas
- Skruvarna bör inte skruvas för hårt tills allt är monterat, i våg och lodat.









OBS! Används elektrisk skruvdragare, kan bulten gå sönder. Hårdra därför manuellt!

- Solen kan göra att rutchbanan blir väldigt varm. Banans nedfart rekommenderas att vändas i norrlig riktning
- Om lekplatsen placeras vid en gångväg mm bör området säkras mot genomfart av gående och cyklister.
- Insprängningshinder bör placeras runt lekutrustning med stor rörelse, t ex, gungställning.
- Det bör vara fri insyn till lekutrustning beräknat till barn under 3 år.

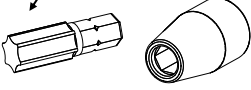
OBS! Under monteringsarbete bör utrustningen som inte ska förankras i marken, ställs så att den inte kan välta.

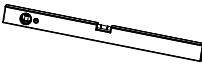
Området måste spärras när lekutrustningen byggs upp, med avspärrningsband eller liknande.

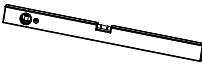
Nødvendig verktøy / Tools required / Nödvändiga verktyg



| | | | | | |
|-----------------------------------|--|---|---|--|--|
| <p>(N)</p> <p>(EN)</p> <p>(S)</p> | <p>(A)</p>  | <p>(B)</p> <p>Torx Nr 45 High quality</p>  | <p>(C)</p> <p>13 + 17mm</p>  | <p>(D)</p>  | <p>(E)</p>  |
| |  | <p>Metermål Metric measure Tumstock</p>  | <p>16 V</p>  | <p>Merkebånd Mark ribbon Märkeband</p>  | <p>5 mm 6 mm</p>  |

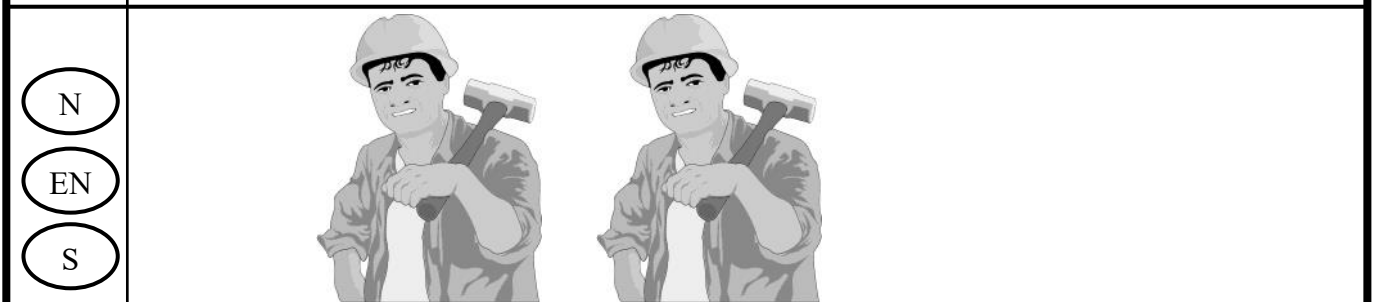



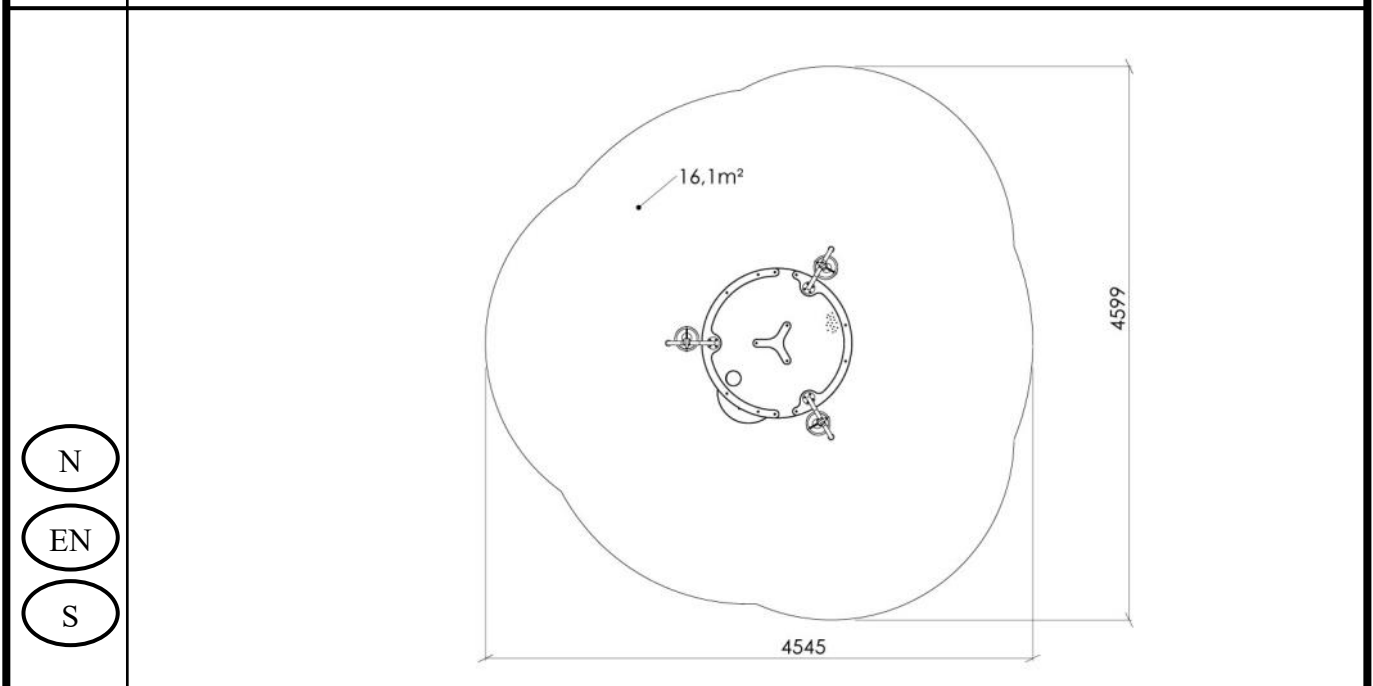

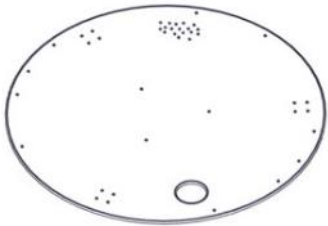
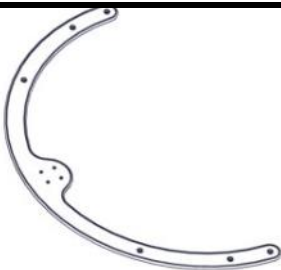
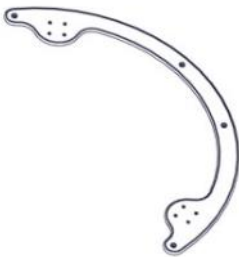
Nødvendig antall personer / Number of persons required / Rekommenderad antal personer

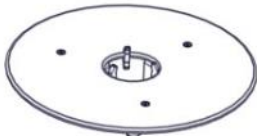

Anbefalt arealbehov ved montering / Recommended working space / Rekommenderad arealbehov vid montering



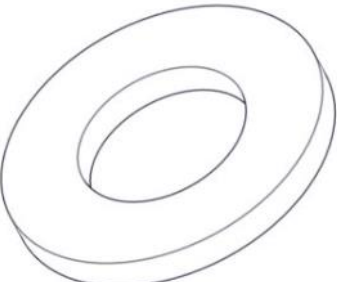

| Boltepakker for / Boltpackage for / Bultpaket för | | Sign. _____. | | |
|---|--|--|------------|------------|
| Mudtable 1250 H600 3 rør 60-164-940 | Navn | Artnr/ dimensjon | Ant | Lev |
|  | Stolpe Ø 110 L=1200 (600-600) Grå Med beslag montert. | 06-200-509 | 3 | |
|  | Mudtable bottom Ø 1250x 12 For 1 rør Grå | 06-200-550 | 1 | |
|  | MudTable Ring Ø1250 del1 Gul | 06-200-501 | 1 | |
|  | MudTable Ring Ø1250 del2 For 2rør Gul | 06-200-552 | 1 | |
|  | MudTable kryss Gul | 06-200-503K (se egen del- montering) | 1 | |
|  | MudTable bucket rest Ø 520 Grønn | 06-200-504K (se egen del- montering) | 1 | |

| Boltepakker for / Boltpackage for / Bultpaket för | | Sign. _____ | | |
|---|--|--|------------|------------|
| Mudtable 1250 H600 3 rør 60-164-940 | Navn | Artnr/ dimensjon | Ant | Lev |
|  | MudTable rør H600 Grå | 06-200-515K (se egen del- montering) | 3 | |
|  | Bøtte med delbare krok | 06-200-518K (se egen del- montering) | 3 | |
|  | Produktmerking | 06-500-500 (se egen del- montering) | 1 | |
|  | Unbrako M8x40 forsenket ho- de Unbrako M8x35 forsenket ho- de | 04-034-040 04-034-035 | 6 4 | |
|  | Skive M8 | 04-050-008 | 10 | |
|  | Låsemutter M8 | 04-040-008 | 10 | |

Boltepakker for / Boltpackage for / Bultpaket för

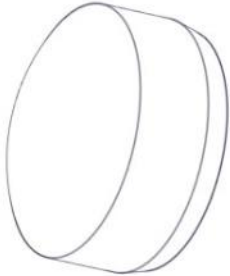
Sign. _____.

| Mudtable 1250 H600 3 rør 60-164-940 | Navn | Artnr/ dimensjon | Ant | Lev |
|---|--------------------------------------|---------------------|-----|-----|
|  | Sikkerhetslette Kropp 32 Sort | 05-301-045 | 10 | |
|  | Sikkerhetslette 20mm hode Sort | 05-301-044 | 10 | |
| | | | | |
| | | | | |
| | | | | |
| | | | | |

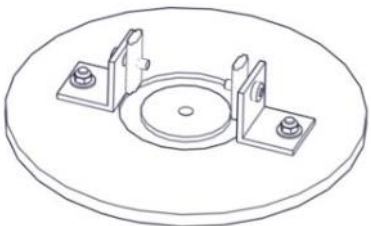
| Boltepakker for / Boltpackage for / Bultpaket för | | Sign. _____. | | |
|---|--------------------------------------|--|-----|-----|
| Mudtable 1250 H600 3 rør 60-164-940 | Navn | Artnr/ dimensjon | Ant | Lev |
| | Fundament Støp | | | |
|  | Støpefundament Ø110 stolpe | 00-003-111K (se egen del- montering) | 3 | |
| | | | | |
| | Fundament Nedgravning | | | |
|  | Nedgravningsfundament Ø110 stolpe | 07-400-101K (se egen del- montering) | 3 | |
| | | | | |

Boltepakker for / Boltpackage for / Bultpaket för

Sign. _____.

Mudtable 1250 H600 3 rør
60-164-940

Navn

Artnr/
dimensjon

Ant

Lev

**Overflatemon-
tering**Fundament 1xØ110 for betong-
dekke00-003-113K
(se egen del-
montering)

3

Stolpe Ø 110 må kappes
Rør må kappes06-200-509
06-200-515K

(3)

(3)

Ref
NS-EN 1176-1
§4.2.8.5

N EN S
Bakkenivå Ground level marknivå

Tykkelse/Thickness

betong
concrete
betong

Stolpe kappes: Lengde stolpe - 600 + tykkelse

Fundamentering med betong / Foundation concrete / Förankring med betong

- (N) Støtdempende materialer
- (EN) Impact attenuating materials
- (S) Støtdämpande material Ref NS-EN 1176-1 §4.2.8.5

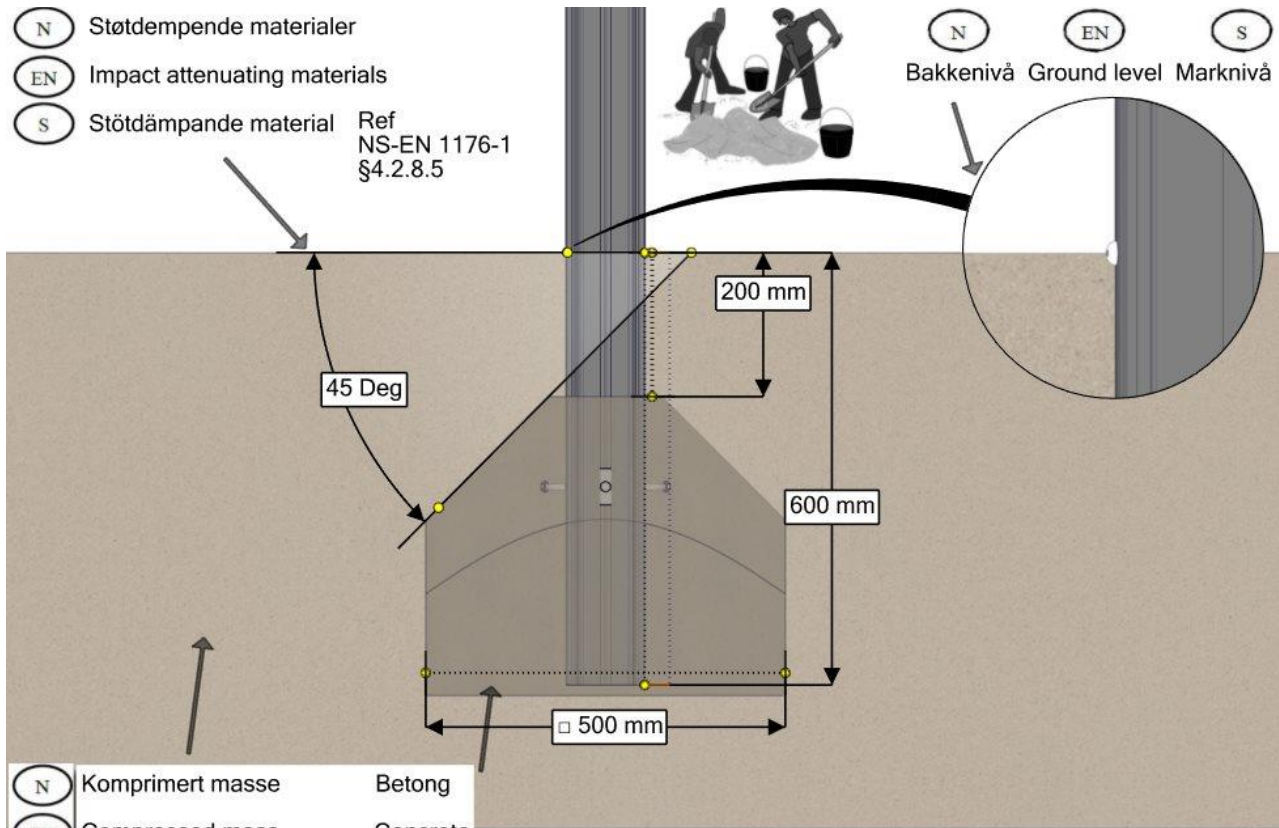

- (N) Komprimert masse Betong
- (EN) Compressed mass Concrete
- (S) Komprimerad massa Betong

Fundamentering uten betong / Foundation without concrete / Förankring utan betong

- (N) Støtdempende materialer
- (EN) Impact attenuating materials
- (S) Støtdämpande material Ref NS-EN 1176-1 §4.2.8.5

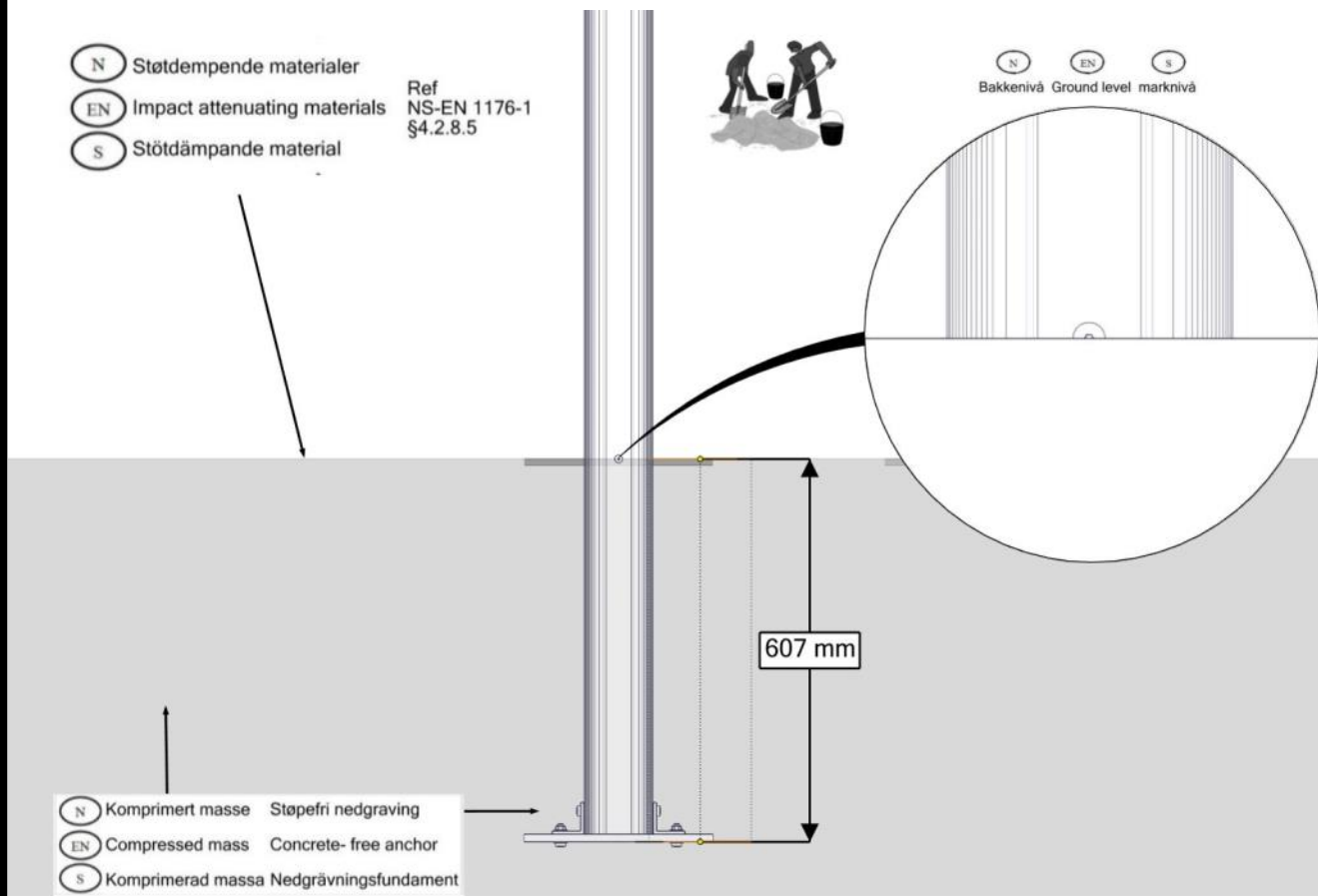

- (N) Komprimert masse Støpefri nedgraving
- (EN) Compressed mass Concrete-free anchor
- (S) Komprimerad massa Nedgravningsfundament

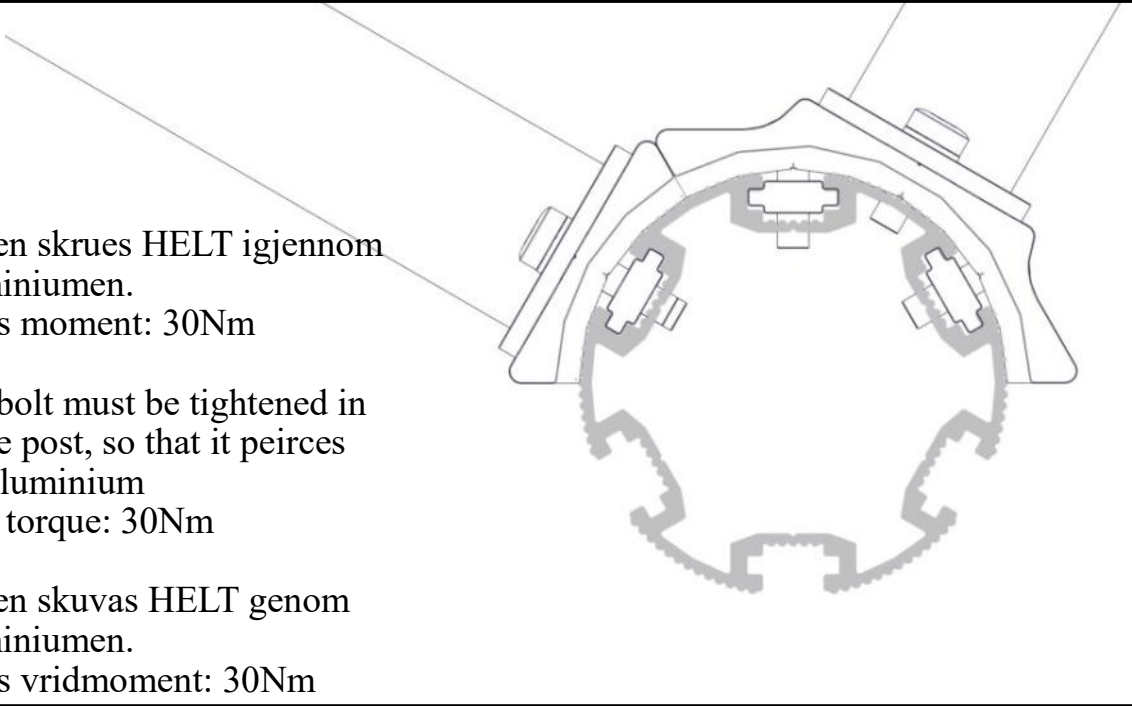
| | | | | |
|---|--|--------------------------|-----------------------------|----|
| <p>(N) Bolten skrues HELT igjennom aluminiumen. Maks moment: 30Nm</p> <p>(EN) The bolt must be tightened in to the post, so that it peirces the aluminium Max torque: 30Nm</p> <p>(S) Bulten skuvas HELT genom aluminiumen. Maks vridmoment: 30Nm</p> |  | | | |
| NO | Betongkvalitet | C25/30 | | |
| SE | Betongkvalitet | | | |
| EN | Concrete quality | | | |
| NO | Mengde betong | 0,3 | m ³ | |
| SE | Mängd betong | | | |
| EN | Amount of concrete | | | |
| NO | Fundament størrelse | 0,5 x 0,5 x 0,4 | m | |
| SE | Stiftelsestorlek | | | |
| EN | Foundation size | | | |
| NO | For sikkerhet må fundamentene med sand eller myk jord være minst 50% større i areal | | | |
| SE | För säkerheten måste grunden med sand eller mjuk jord vara minst 50% större i området | | | |
| EN | For safety, the foundations with sand or soft soil must be at least 50% larger in area | | | |
| NO | Tyngste element | 06-200-550 | 21 | Kg |
| SE | Tyngsta element | | | |
| EN | Heaviest element | | | |
| NO | Største element | 06-500-550 06-200-515 | Ø 1,25x0,02 1,4x0,4x0,05 | m |
| SE | Största element | | | |
| EN | Biggest element | | | |

Fallhøyder / Free height of fall / Fallhöjder

Fallhøyde = 0,63 meter

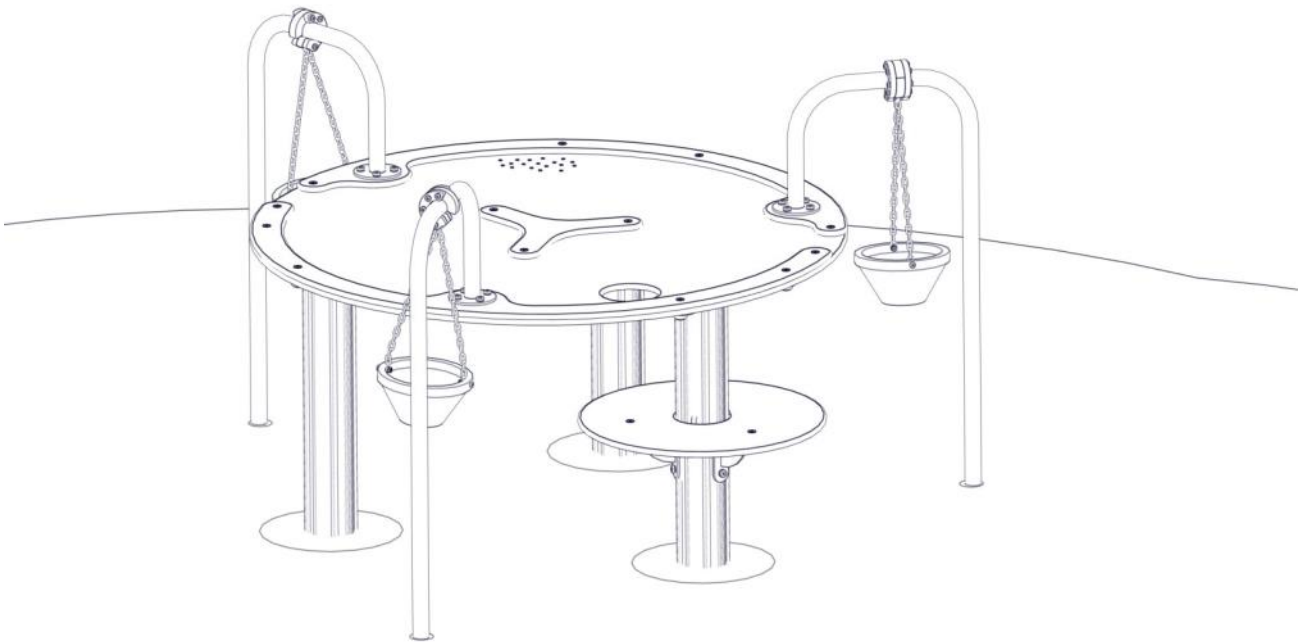
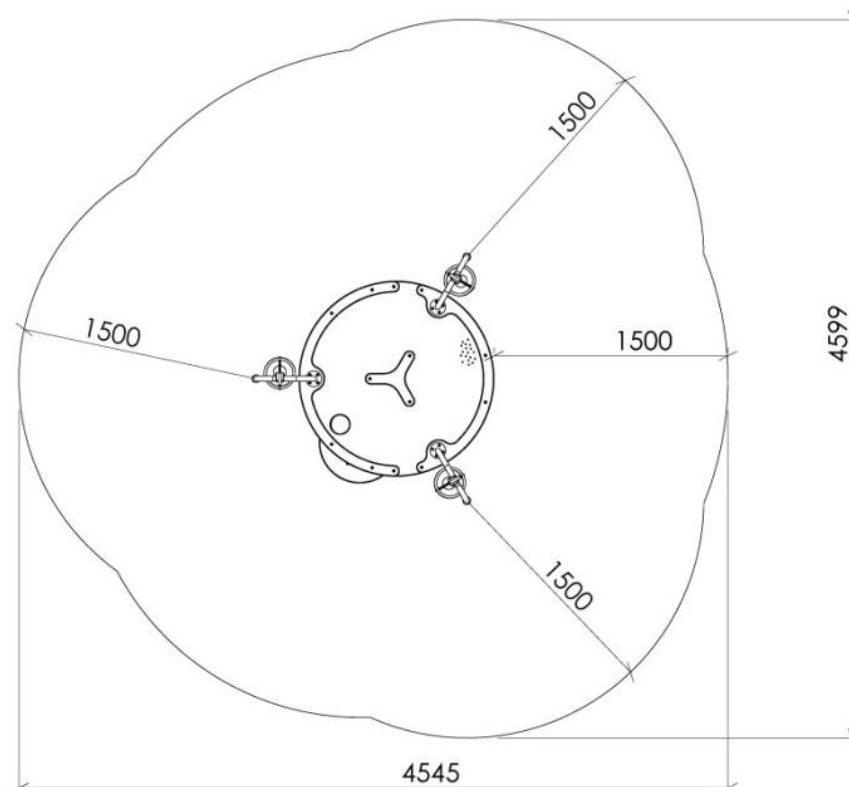
**Sikkerhetszone / Safety zone / Säkerhetszon**

Montering av lekeapparatet / Assembly instructions / Montering av lekredskapet

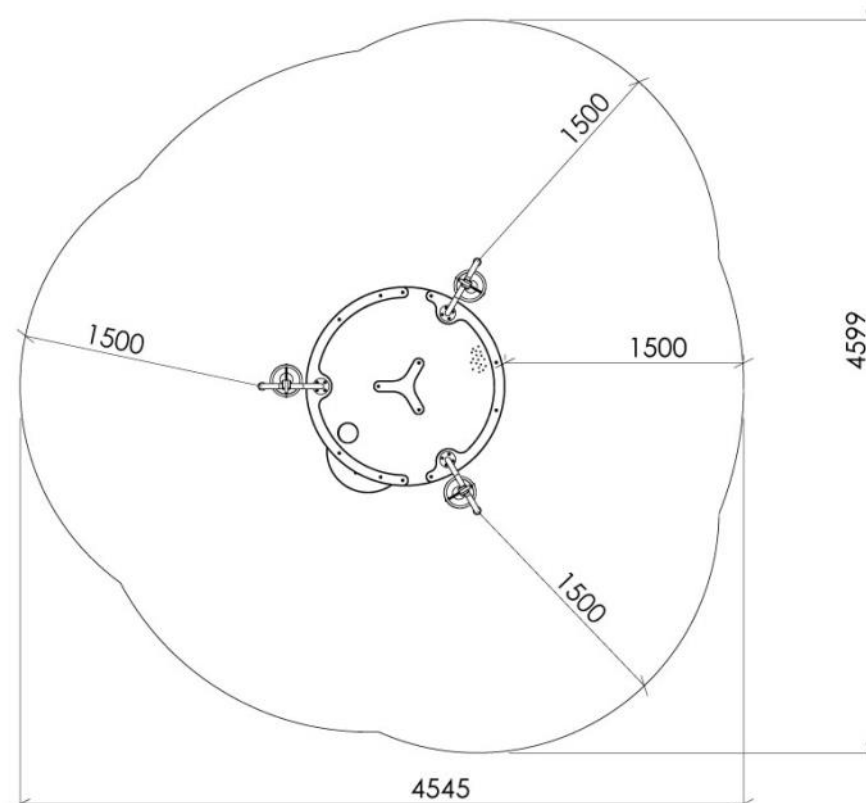

Se separat delmontering for detaljer
 See separate assembly for details
 Se separata delmontering för detaljer

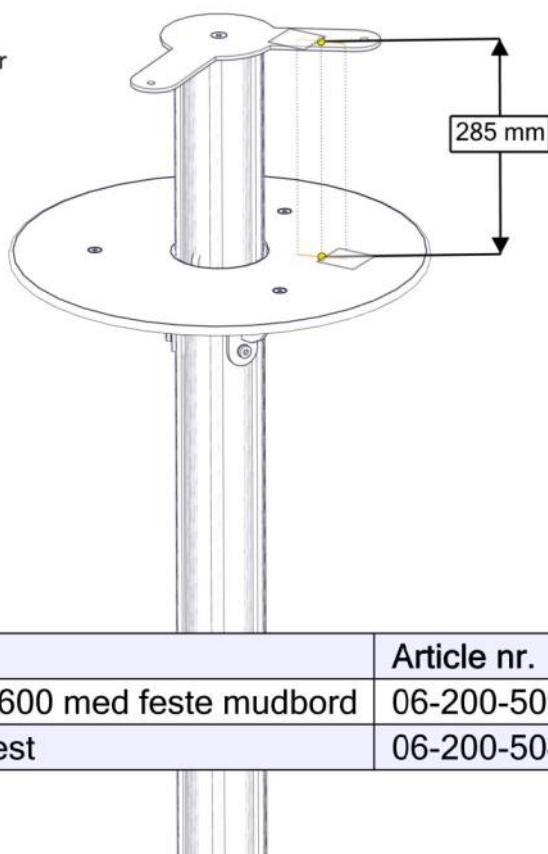

| Part Name | Article nr. | Qty |
|--|-------------|-----|
| Stolpe L1100=500-600 med feste mudbord | 06-200-509 | 1 |
| MudTable bucket rest | 06-200-504K | 1 |

Se separat delmontering for detaljer
 See separate assembly for details
 Se separata delmontering för detaljer

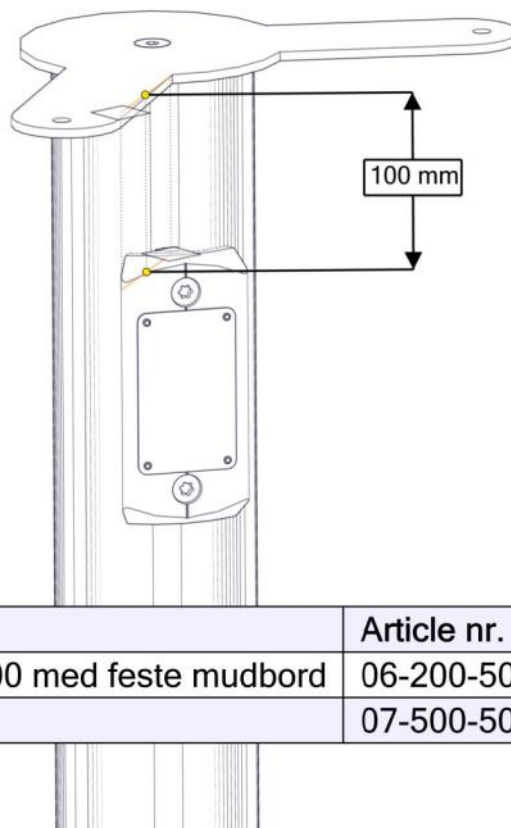

| Part Name | Article nr. | Qty |
|--|-------------|-----|
| Stolpe L1100=500-600 med feste mudbord | 06-200-509 | 1 |
| Produktmerke | 07-500-500 | 1 |

Se separat delmontering for detaljer
 See separate assembly for details
 Se separata delmontering för detaljer

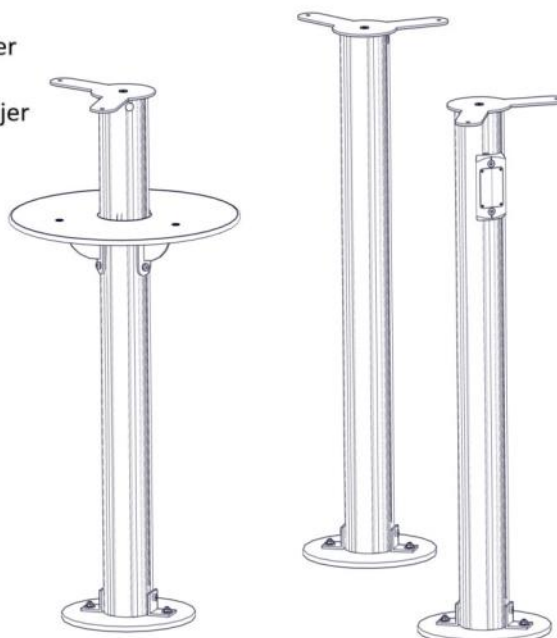

| Part Name | Article nr. | Qty |
|--|-------------|-----|
| Stolpe L1100=500-600 med feste mudbord | 06-200-509 | 1 |
| Fundamentplate 1x110 stolpe komplett | 07-400-101K | 3 |

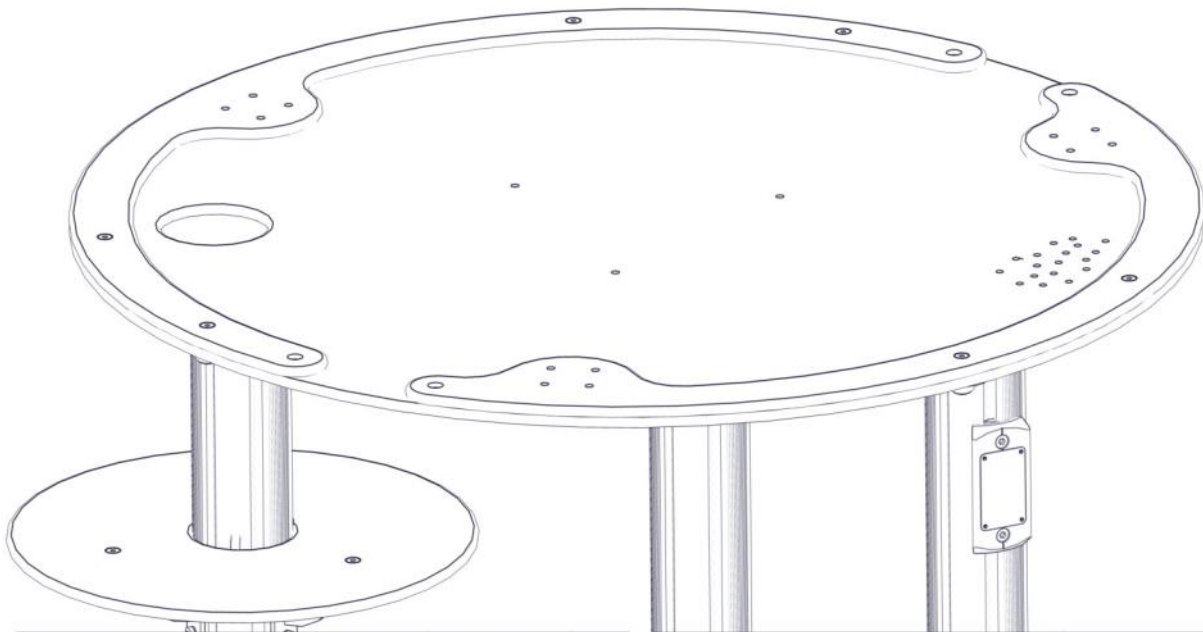

| Part Name | Article nr. | Qty |
|---------------------------------------|-------------|-----|
| Unbrako skrue M8x40 forsenket hode | 04-034-040 | 6 |
| Skive M8 | 04-050-008 | 6 |
| Sikkerhetshette kropp 32 svart for M8 | 05-301-045 | 6 |
| Sikkerhetshette 20mm svart for M8 | 05-301-044 | 6 |
| MudTable ring 1250 del2 | 06-200-552 | 1 |

| Part Name | Article nr. | Qty |
|---------------------------|-------------|-----|
| MudTable ring 1250 del1 | 06-200-501 | 1 |
| MudTable plate 1250 3 rør | 06-200-550 | 1 |
| Låsemutter M8 | 04-040-008 | 6 |

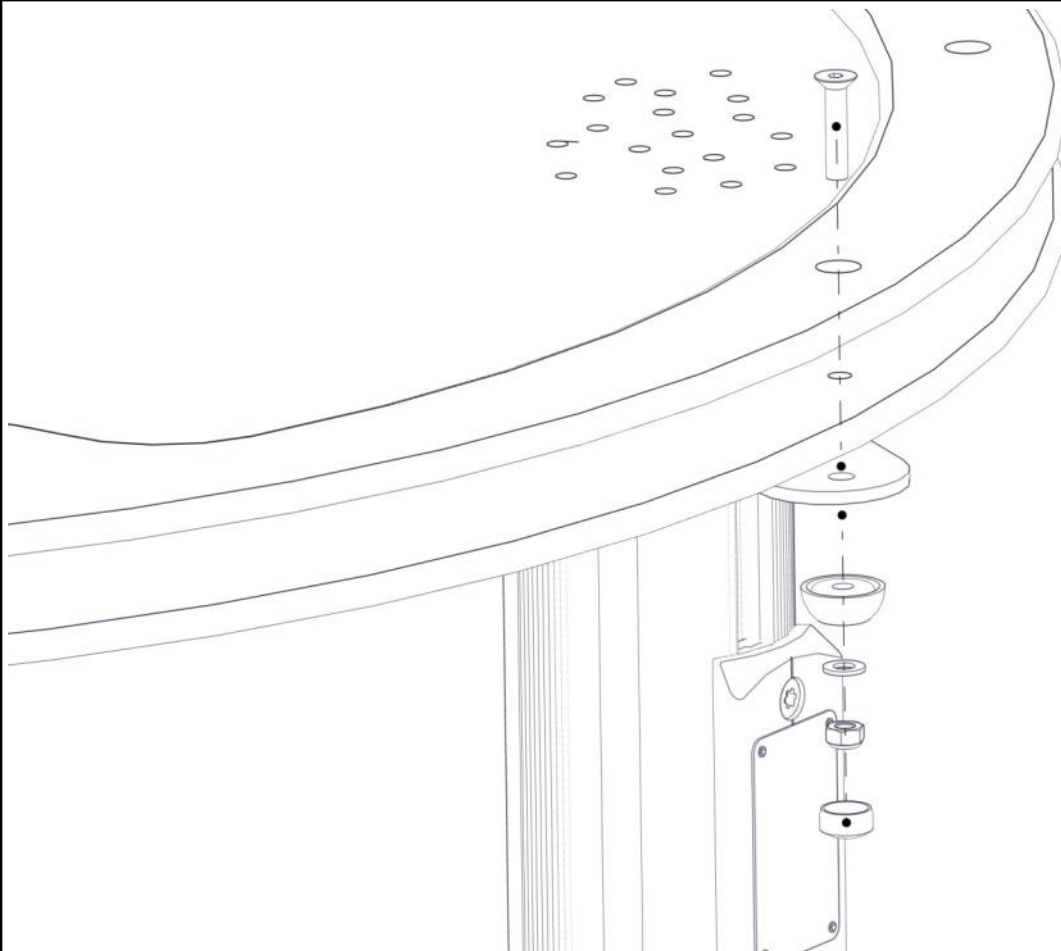

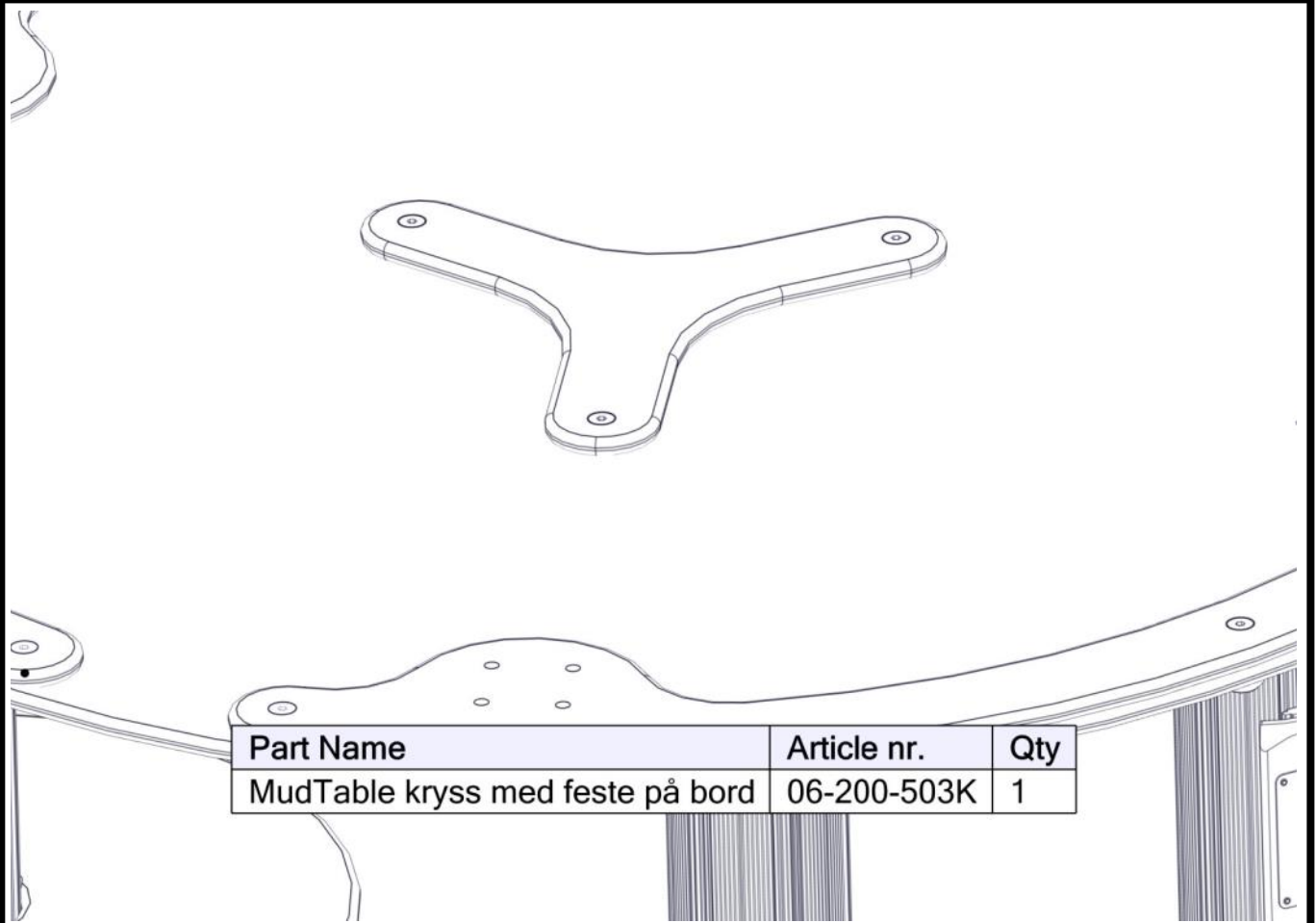
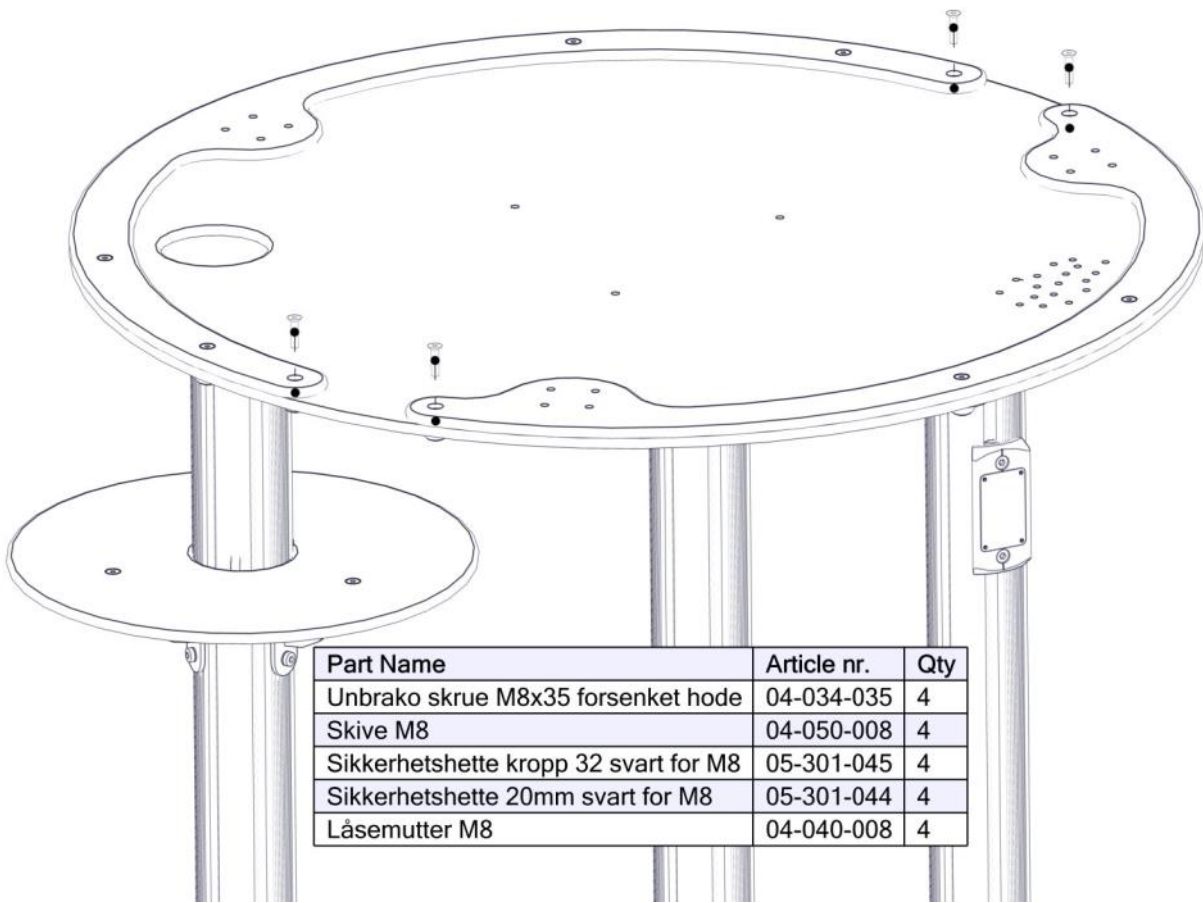

Se separat delmontering for detaljer
 See separate assembly for details
 Se separata delmontering för detaljer

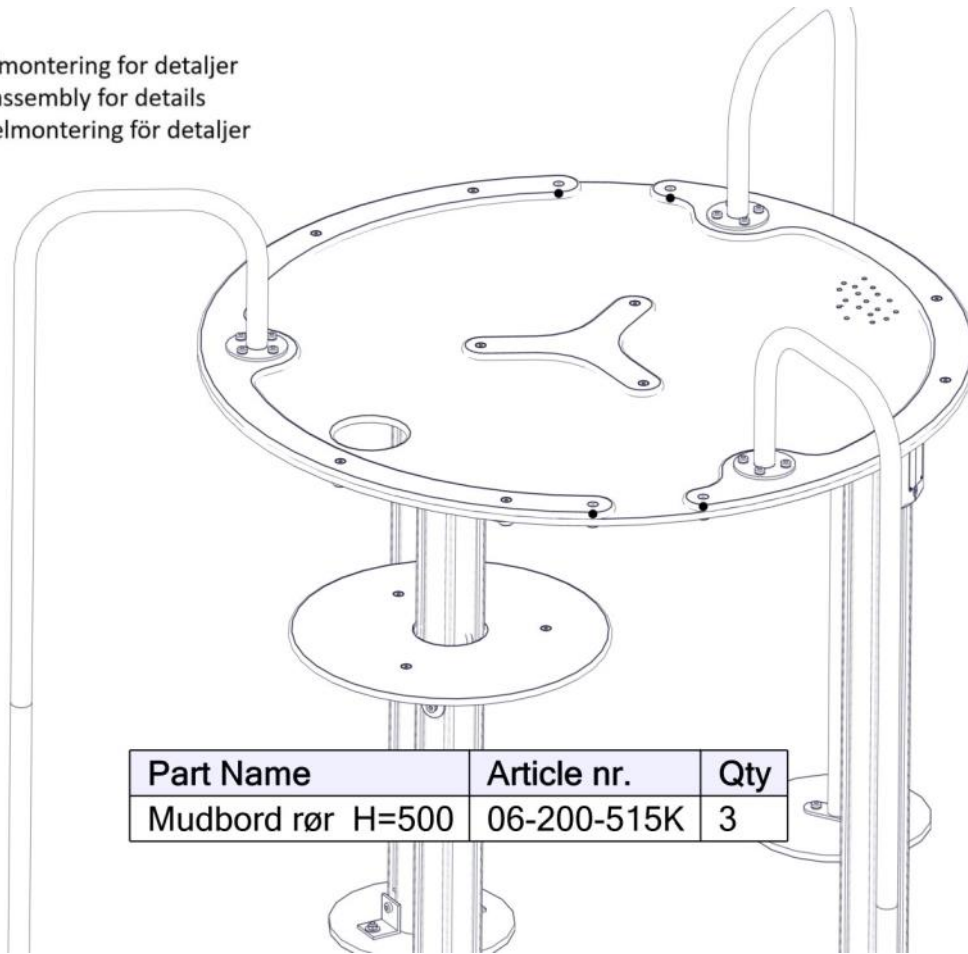



| Part Name | Article nr. | Qty |
|-------------------|-------------|-----|
| Mudbord rør H=500 | 06-200-515K | 3 |

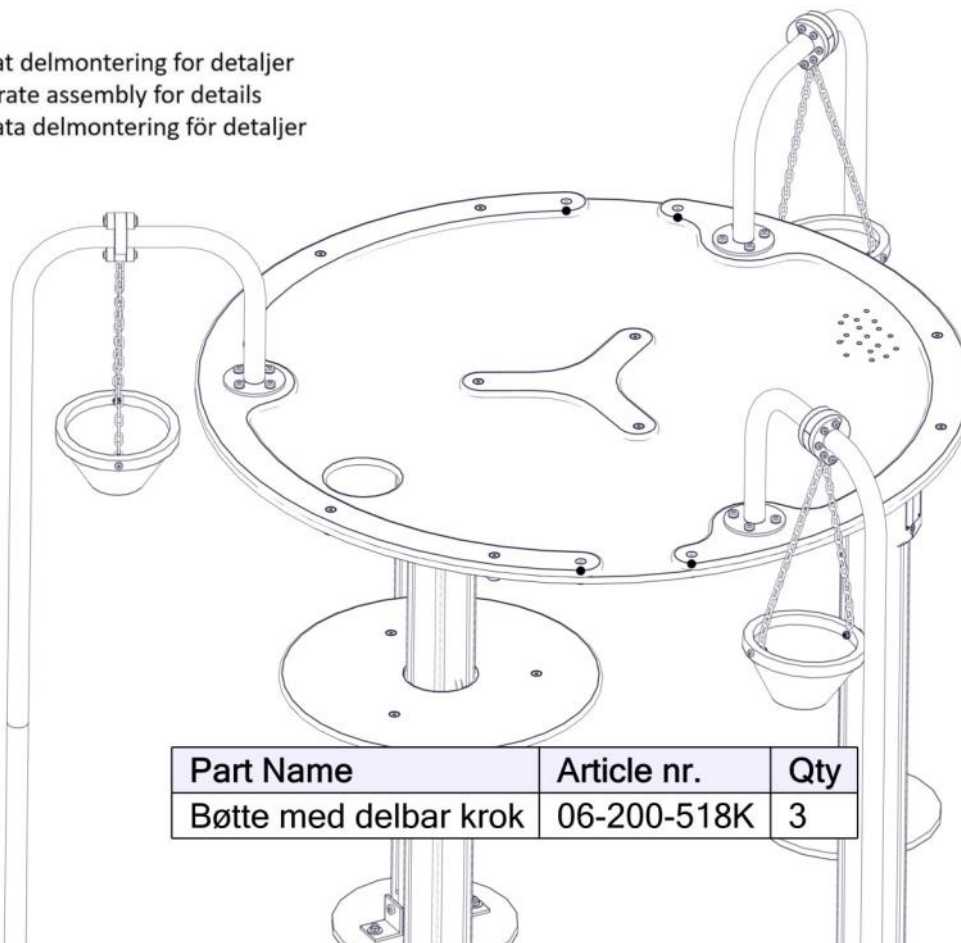



Se separat delmontering for detaljer
 See separate assembly for details
 Se separata delmontering för detaljer

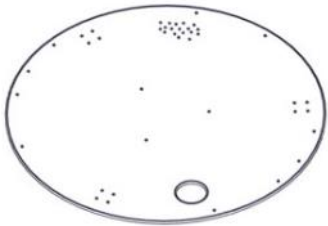
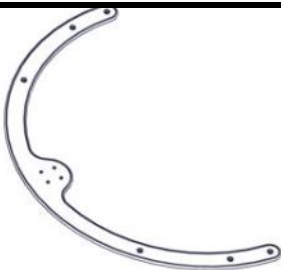
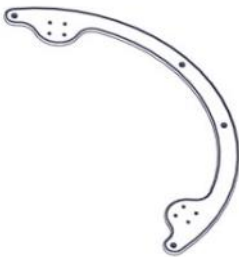

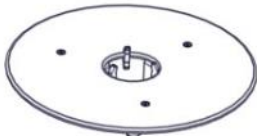
| Part Name | Article nr. | Qty |
|-----------------------|-------------|-----|
| Bøtte med delbar krok | 06-200-518K | 3 |

| Før utstyret tas i bruk / Before play begins / Innan lekredskapet tas i bruk | |
|---|---|
| N | <ul style="list-style-type: none"> ● Påse at fallunderlag er utlagt i henhold til gjeldende regler eller vår anbefaling ● Fjern alle monteringshjelpemidler (rester av betong, planker, paller, plast, og lignende) ● Før utstyret tas i bruk, burde man sjekke at det ikke er fare for at anorakksnorer og lignende som kan hekte seg fast noen steder på lekeapparatet. (Vedlagte snor med dobbe (kneledd) kan brukes til å sjekke at dette er i orden. Se vedlagte veiledning for bruk av denne. Dette gjøres for å oppdage eventuelle feilmonteringer.? ● NB! Bør stå i 2-3 dager før bruk |
| EN | <ul style="list-style-type: none"> ● Make sure the area and depth of safer surfacing are according to the current standard, or to the manufacturer's recommendation ● Make sure all tools and surplus materials are removed before play begins ● PS! When complete, allow 2-3 days for the concrete to set before use |
| S | <ul style="list-style-type: none"> ● Kontrollera att fallunderlag är utlagt enligt gällande regler eller vårt rekommendation ● Ta bort alla monteringshjälpmedel (rester av betong, plankor, pallar, plast och liknande) ● Innan lekredskapet används, kontrollera att anoracksnoddar eller kläder/delar av kläder eller liknande inte kan fastna i några delar på redskapet. (Den bipackade "knävringen" kan man med fördel användas för denna kontroll. ● Detta görs för att upptäcka eventuella felmonteringar.) |

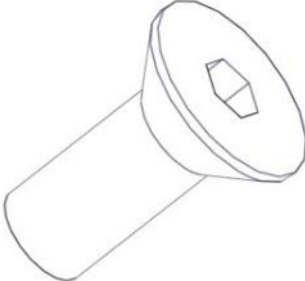
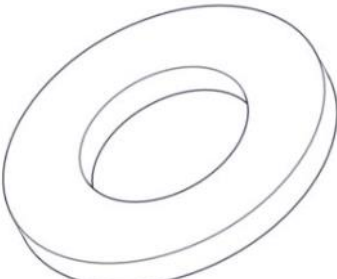
| Boltepakker for / Boltpackage for / Bultpaket för | | Sign. _____. | | |
|---|--|--|------------|------------|
| Mudtable 1250 H600 3 rør 60-164-940 | Navn | Artnr/ dimensjon | Ant | Lev |
|  | Stolpe Ø 110 L=1200 (600-600) Grå Med beslag montert. | 06-200-509 | 3 | |
|  | Mudtable bottom Ø 1250x 12 For 1 rør Grå | 06-200-550 | 1 | |
|  | MudTable Ring Ø1250 del1 Gul | 06-200-501 | 1 | |
|  | MudTable Ring Ø1250 del2 For 2rør Gul | 06-200-552 | 1 | |
|  | MudTable kryss Gul | 06-200-503K (se egen del- montering) | 1 | |
|  | MudTable bucket rest Ø 520 Grønn | 06-200-504K (se egen del- montering) | 1 | |

| Boltepakker for / Boltpackage for / Bultpaket för | | Sign. _____ | | |
|---|--|--|------------|------------|
| Mudtable 1250 H600 3 rør 60-164-940 | Navn | Artnr/ dimensjon | Ant | Lev |
|  | MudTable rør H600 Grå | 06-200-515K (se egen del- montering) | 3 | |
|  | Bøtte med delbare krok | 06-200-518K (se egen del- montering) | 3 | |
|  | Produktmerking | 06-500-500 (se egen del- montering) | 1 | |
|  | Unbrako M8x40 forsenket ho- de Unbrako M8x35 forsenket ho- de | 04-034-040 04-034-035 | 6 4 | |
|  | Skive M8 | 04-050-008 | 10 | |
|  | Låsemutter M8 | 04-040-008 | 10 | |

Boltepakker for / Boltpackage for / Bultpaket för

Sign. _____.

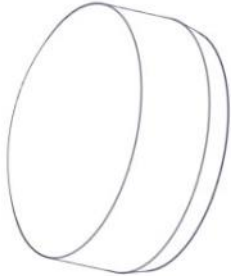
| Mudtable 1250 H600 3 rør 60-164-940 | Navn | Artnr/ dimensjon | Ant | Lev |
|---|--------------------------------------|---------------------|-----|-----|
|  | Sikkerhetshette Kropp 32 Sort | 05-301-045 | 10 | |
|  | Sikkerhetshette 20mm hode Sort | 05-301-044 | 10 | |
| | | | | |
| | | | | |
| | | | | |
| | | | | |

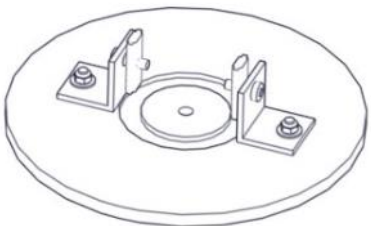
| Boltepakker for / Boltpackage for / Bultpaket för | | Sign. _____ | | |
|---|--------------------------------------|--|-----|-----|
| Mudtable 1250 H600 3 rør 60-164-940 | Navn | Artnr/ dimensjon | Ant | Lev |
| | Fundament Støp | | | |
|  | Støpefundament Ø110 stolpe | 00-003-111K (se egen del- montering) | 3 | |
| | | | | |
| | Fundament Nedgravning | | | |
|  | Nedgravningsfundament Ø110 stolpe | 07-400-101K (se egen del- montering) | 3 | |
| | | | | |

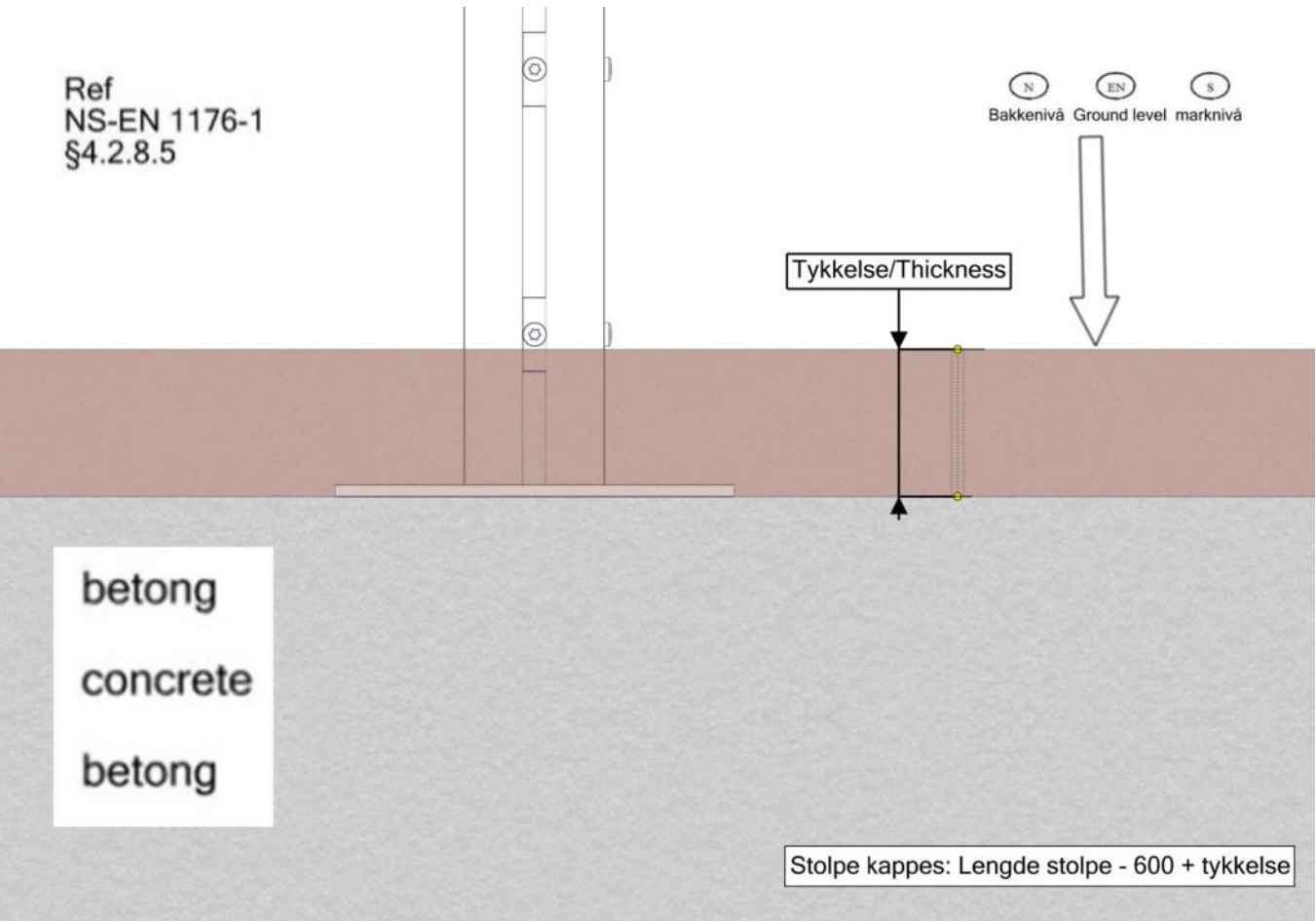
| Boltepakker for / Boltpackage for / Bultpaket för | | Sign. _____ | | |
|---|---|--|------------|-----|
| Mudtable 1250 H600 3 rør 60-164-940 | Navn | Artnr/ dimensjon | Ant | Lev |
| | Overflatemon- tering | | | |
|  | Fundament 1xØ110 for betong- dekke | 00-003-113K (se egen del- montering) | 3 | |
| | Stolpe Ø 110 må kappes Rør må kappes | 06-200-509 06-200-515K | (3) (3) | |
| <p>Ref NS-EN 1176-1 §4.2.8.5</p>  <p>betong concrete betong</p> <p>Tykkelse/Thickness</p> <p>Bakkenivå Ground level marknivå</p> <p>Stolpe kappes: Lengde stolpe - 600 + tykkelse</p> | | | | |